

Instruction manual

OMRON

U22

MICRO *A-I-R*™

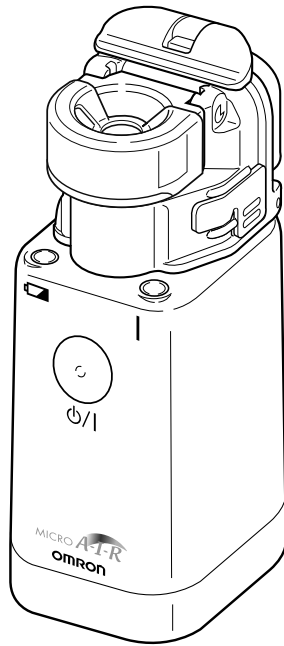

- English
- Deutsch
- Nederlands
- العربية

All for Healthcare

IM-NE-U22-E-08-01/2014
1665580-0F

Table of contents

Intended use	3
Safety precautions	4
Features and benefits	5
Contents of the OMRON MicroAIR U22 package	6
Names and functions of the parts	7
How to insert or replace the batteries	9
How to assemble the unit and fill the medication container. . .	10
How to select the nebulization mode	13
How to inhale with the OMRON MicroAIR U22	14
How to clean the unit after each inhalation	15
How to disinfect the unit each day	17
How to replace the mesh cap	19
Troubleshooting	20
Technical data	22
Optional Medical Accessories	26

Dear customer,

Thank you for purchasing the OMRON MicroAIR U22 Nebulizer.

By buying the MicroAIR U22 nebulizer, you have chosen a high-quality, innovative device.

During its development, particular attention was given to reliability, easy and convenient handling.

Before using the nebulizer for the first time, please read through this manual carefully.

If you still have any questions regarding its use, contact OMRON customer service at the address shown on the packaging or in this instruction manual. They will be pleased to assist you.

OMRON HEALTHCARE EUROPE B.V.

Intended use

Medical Purpose	This product is intended to be used for inhaling medication for respiratory disorders.														
Intended User	<ul style="list-style-type: none">• Legally certified medical experts, such as doctor, nurse and therapist, or healthcare personnel or patient under the guidance of qualified medical experts.• The user should also be capable of understanding general operation of MicroAIR U22 and the content of instruction manual.														
Intended Patients	This product should not be used by patients, who are unconscious or are not breathing spontaneously.														
Environment	This product is intended for use in a medical facility, such as Hospital, clinic and doctor's office, in a room of general household, and in open-air environment with a roof.														
Durable period	Durable periods are as follows, provided the product is used to nebulize saline 3 times a day for 10 minutes each time at room temperature (23°C). Durable period may vary depending on usage environment. <table><tr><td>Main Unit</td><td>5 years</td></tr><tr><td>Medication Container</td><td>1 year</td></tr><tr><td>Mesh Cap</td><td>1 year</td></tr><tr><td>Mouthpiece</td><td>1 year</td></tr><tr><td>Adult Mask (PVC)</td><td>1 year</td></tr><tr><td>Child Mask (PVC)</td><td>1 year</td></tr><tr><td>Mask Adapter</td><td>1 year</td></tr></table>	Main Unit	5 years	Medication Container	1 year	Mesh Cap	1 year	Mouthpiece	1 year	Adult Mask (PVC)	1 year	Child Mask (PVC)	1 year	Mask Adapter	1 year
Main Unit	5 years														
Medication Container	1 year														
Mesh Cap	1 year														
Mouthpiece	1 year														
Adult Mask (PVC)	1 year														
Child Mask (PVC)	1 year														
Mask Adapter	1 year														
Precautions for use	Warnings and cautions described in the instruction manual should be observed.														

Safety precautions

- This nebulizer is a medical device. Only use medications as prescribed and instructed by your doctor.
- Disinfect the nebulizer before first use and at least once per day when in use. See page 17 for disinfection instructions.
- Clean the nebulizer after each inhalation. See page 15 for cleaning instructions.
- Only use the nebulizer for its intended purpose; for inhalation therapy. Any other form of use constitutes an improper use and is therefore dangerous. The manufacturer cannot be held liable for any damage caused by improper or incorrect use.
- Do not leave the nebulizer unattended with people who require supervision (e.g. people with infirmities or children).
- The nebulizer does not contain user serviceable parts. Never open the main unit. In case of problems, stop using the nebulizer and contact your OMRON dealer.
- Do not wash the main unit with water; do not immerse it in water.
- Do not drop medication on the main unit. If you drop medication, immediately wipe it off.
- Do not apply strong shocks to the nebulizer.
- Although this device complies with the provisions of the EMC (Electromagnetic Compatibility) directive, operating the device should be avoided in direct vicinity of other electronic devices.
- Keep this manual for future reference.

Features and benefits

In the MicroAIR U22, aerosol is generated by pushing liquid medication through fine holes in the newly developed metal alloy mesh. This is realised by a titanium vibrator, oscillating at high frequency. This unique technology offers the following features and benefits:

True portable, pocket size

The device will fit in any handbag or briefcase. Running up to 4 hours on just two penlite batteries, your medication is always within reach wherever you go, whatever you do.

Inhalation is possible at various angles

The device enables inhalation at various angles with stable nebulization. Therefore the device can be used even while in bed or can be used for a baby/child, laying in the arms of the care-taker.

Soundless operation

The soundless operation of the device enables discrete use.

No loud frightening noises, meaning calm treatment even while using it on a sleeping child.

Simple one-button operation

Wide medication compliance

Low medication waste and residue

Contents of the OMRON MicroAIR U22 package

The following items are contained in the package:

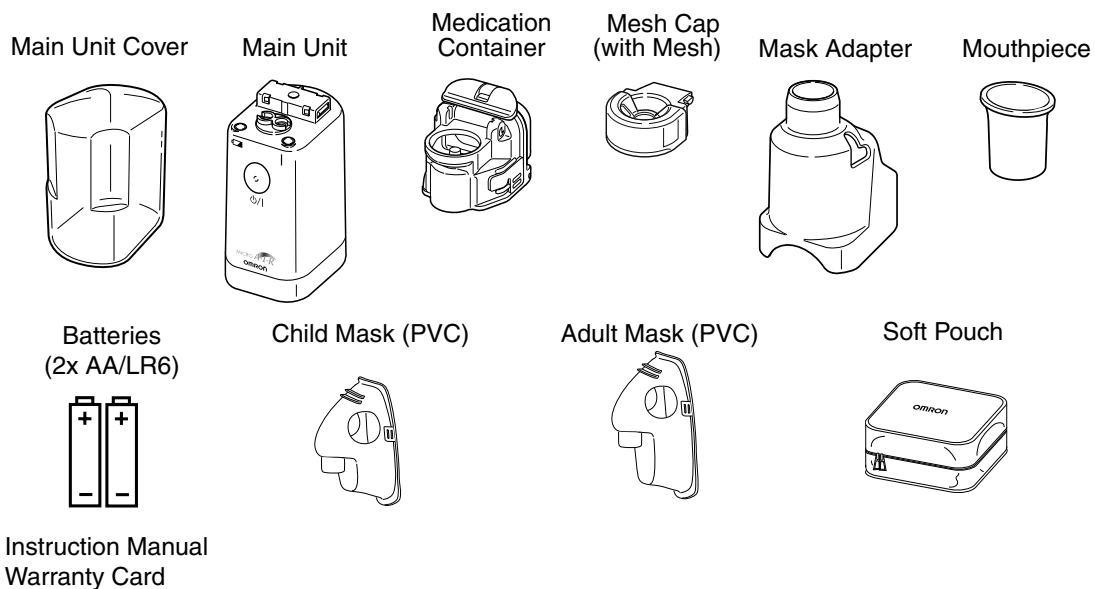

Names and functions of the parts

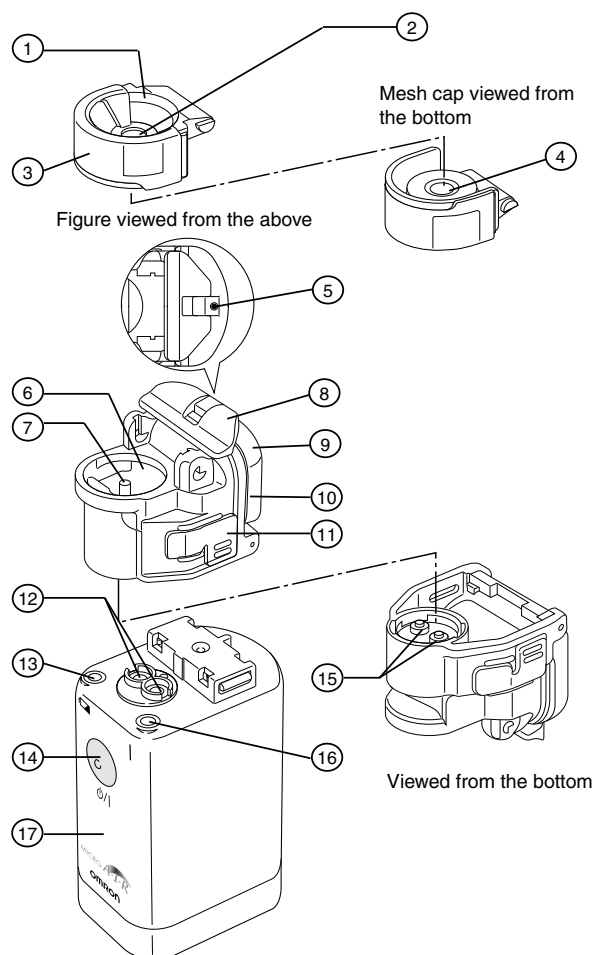

1. **Mesh Cap**
Contains metal alloy mesh for nebulization.
2. **Nebulization port**
Nebulized medication exits here.
3. **Mesh Cap Cover**
Protects the mesh.
4. **Mesh**
Efficient nebulization is realized through the use of minute pores.
Do not touch this fragile part with your fingers!
Do not attempt to clean with a cotton swab or a pin!
5. **Air port**
Stabilizes nebulization.
6. **Medication Port**
Medication can be filled here by opening the mesh cap.
7. **Vibrator**
The tip of this vibrator oscillates at high frequency and pushes the medication through the pores of the mesh.
8. **Medication container cap locking lever**
Opens the medication container cap.
9. **Medication container cap**
To be opened for cleaning the medication container.

Names and functions of the parts

10. **Container**
Contains the medication (7 ml max.)
11. **Medication container release button**
Medication container can be removed when the buttons on both sides are pushed.
12. **Electrodes**
Connects the main unit with the vibrator.
13. **Battery Low Indicator**
An orange light blinks when the batteries are low.
14. **ON/OFF button**
15. **Electrodes**
Connects the vibrator with the main unit.
16. **Power indicator**
A green light turns on when the power is on.
17. **Main unit**

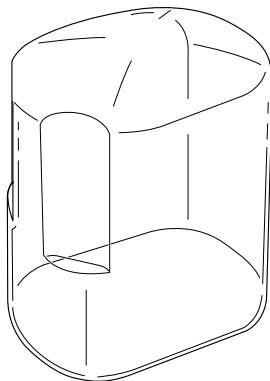

Main unit cover
Protects the main unit.

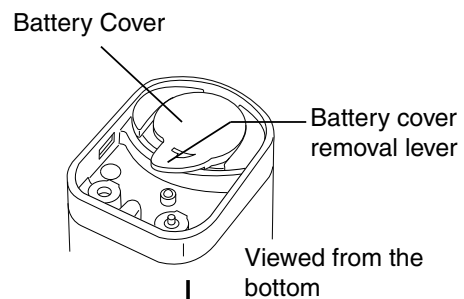
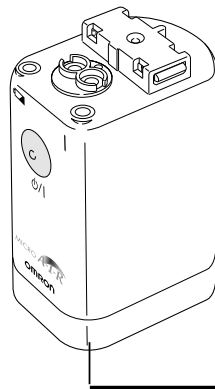

How to insert or replace the batteries

Inserting batteries

1. Remove the battery cover by slightly rotating the disengaging lever in the direction of the arrow (1).
2. Insert the batteries according to the battery polarity indicated inside the battery compartment.
3. Replace battery cover by aligning tabs and, with your thumbs, push into place until it clicks.

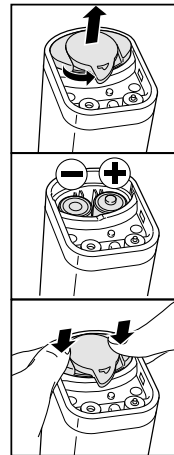

Battery life and battery replacement

The unit can operate with alkaline batteries or with nickel-metal-hydrate (NiMH) rechargeable batteries. Depending on the capacity and condition of the batteries, the unit can operate up to 8 days on a set of batteries based on usage of 30 minutes a day.

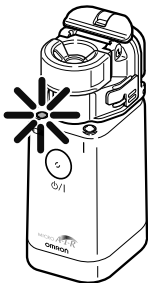

- Notes:
- When the battery low indicator (orange) flashes, the batteries should be replaced. Replace **both** batteries with new ones.
 - Remove batteries if the unit is not in use for long periods. Failure to do so could result in damage due to battery leakage.
 - Batteries should be treated as chemical waste; disposal should be done at your retail store or at appropriate collection locations.

How to assemble the unit and fill the medication container

When using the unit for the first time or after not using it for a long period of time, clean and disinfect the medication container, mesh, mask adapter, mouthpiece and mask. Refer to page 15 for instructions.

1. Insert batteries, see page 9.
2. Remove the medication container from the main unit.
To do so, push on the release buttons on both sides.
This will disengage the latch mechanism.

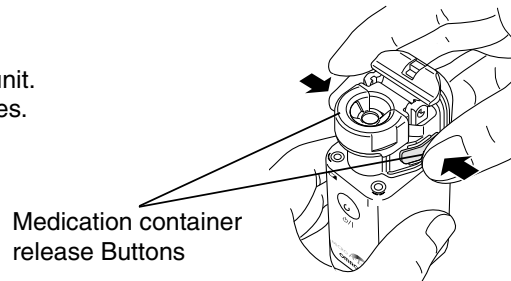

3. Remove the mesh cap by placing your thumb under the rim, gently pushing up, tilt the cap back until perpendicular and lift straight up.

Hold the medication bottle as illustrated.

Do not touch the mesh!

Lift up the Mesh Cap
by placing your thumb
under the rim.

How to assemble the unit and fill the medication container

4. Fill the medication container as illustrated.
The maximum capacity is 7 ml.

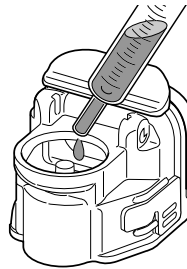

5. Install the mesh cap.

Do not touch the mesh!

The mesh cap seals the medication bottle. Confirm if the cap is securely installed.

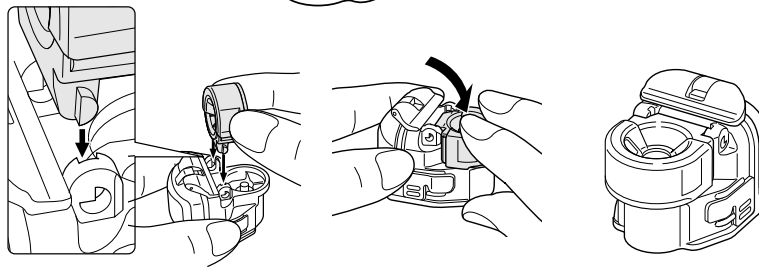

6. Install the medication container on the main unit.

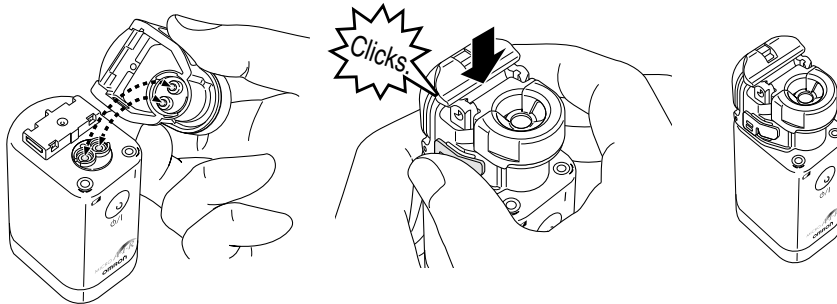

How to assemble the unit and fill the medication container

7. Install the mask adapter on the main unit.

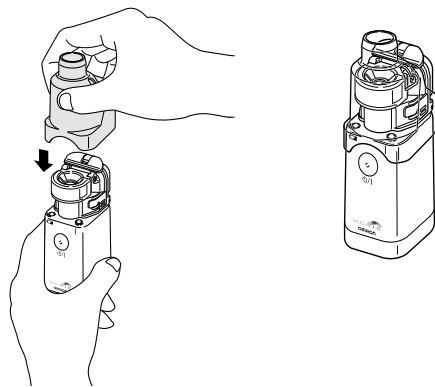

8. Install the mask or mouthpiece on the mask adapter.

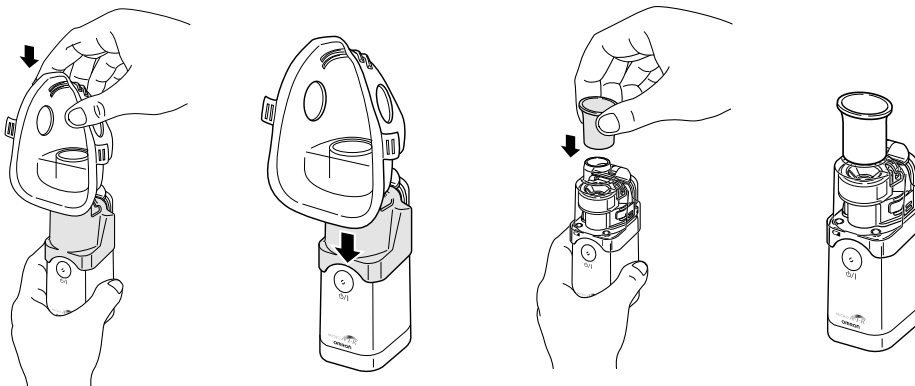

The device is now ready for use.

Refer to the next section on how to select the nebulization mode and how to inhale.

How to select the nebulization mode

Continuous nebulization mode

If you push the ON/OFF (⏻/ I) button and release within approximately 1 second, the unit nebulizes in continuous mode.

If you push the ⏻/ I button again, the unit stops nebulization.

The green power indicator lights up during nebulization.

Manual nebulization mode

If you hold the ON/OFF (⏻/ I) button for approx. 2 seconds or more, the unit nebulizes in the manual nebulization mode.

The unit only nebulizes while you keep on pressing the ⏻/ I button and stops nebulization when you remove your finger from the button.

In this mode, nebulization may be synchronised with your Inhalation/exhalation cycle and medication waste is minimized.

The green power indicator lights up during nebulization.

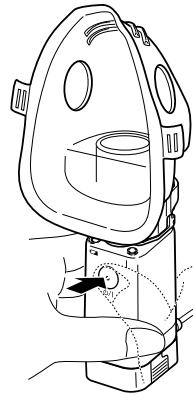

How to inhale with the OMRON MicroAIR U22

⚠ Caution: Only use type and amount of medications as prescribed and instructed by your doctor.

1. Slightly tilt the unit as illustrated in the figure. In this position, the vibrator is immersed in the medication and nebulization will start after power on.

After the vibrator has been immersed in the medication, the unit can be used under any angle.

⚠ Caution: In some positions (e.g. upright), nebulization may stop after a short while. In that case, briefly tilt the unit again in order to re-immers the vibrator in the medication.

2. Place the mouthpiece in your mouth or place the mask over mouth and nose.

Always be calm and relaxed when you inhale. Breathe in slowly and deeply so that the medication can reach deep in to the bronchial tubes. Hold your breath briefly, then breathe out slowly while removing the mouthpiece from your mouth. Do not breathe too quickly. Pause when you feel like having a rest.

You may synchronise the nebulization with your inhalation/exhalation cycles by using the unit in 'manual nebulization mode'. Refer to page 13.

Note:

If high-**viscosity** medication is used, nebulization may be reduced.

If excessive medication collects on the mesh, nebulization may stop. In that case, turn off the power and remove the mask adapter. Absorb the medication by means of a lint-free cloth.

⚠ Caution: Do not poke the mesh with a cotton swap or a pin; the mesh may be permanently damaged.

After inhalation always switch off the nebulizer by pressing the (⏻ / I) button.

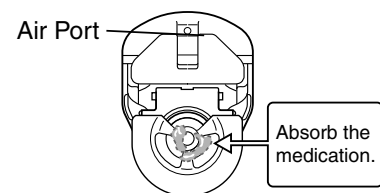
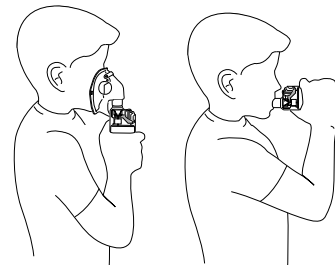
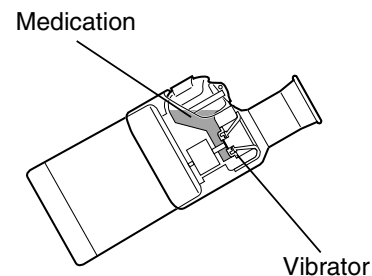

How to clean the unit after each inhalation

Note: if the device is not cleaned and disinfected correctly and frequently, micro-organisms may remain in the unit, causing risk of infection.

The following items should be cleaned **after each use**:
Medication container, mesh cap, mask adapter,
mouthpiece and mask.

1. Remove the mask adapter from the main unit.
2. Remove the medication container from the main unit:

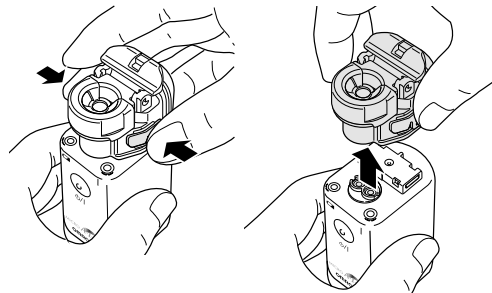

3. Remove the mesh cap from the medication container, discard the medication and open the medication container cap. It is recommended to nebulize clean water to remove medication left in the mesh holes after discarding the medication.

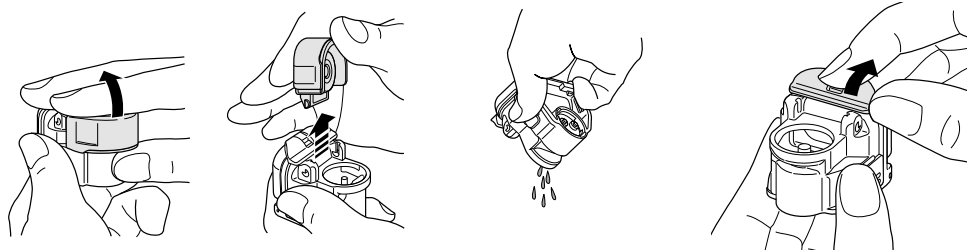

4. Remove the mesh cover from the mesh cap.

⚠ Caution: Do not touch the mesh.

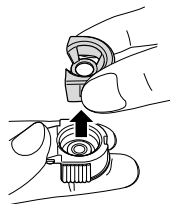

How to clean the unit after each inhalation

5. Wash the parts (not the main unit!) in a warm soapy solution.
Rinse the parts in warm tap water to remove the soap residue.

Some types of medications can easily remain on the mesh, therefore pay close attention during washing.
Do not touch the mesh with a cotton swab, or with a pin.

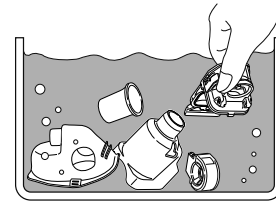

6. Shake off excessive water from the parts and let them air dry on a clean, lint free (paper) towel.

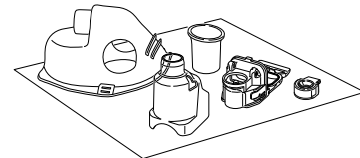

7. Clean the main unit and its electrodes by wiping it off with a (moistened) gauze.
Use a dry gauze to wipe the main unit dry.
Do not use volatile agents, such as benzene or thinner.

8. Assemble the unit, refer to page 10.

9. Store the unit in a dry, clean place.

How to disinfect the unit each day

Note: if the device is not cleaned and disinfected correctly and as frequently as indicated, microorganisms may remain in the unit, causing risk of infection.

The medication container, mesh cap, mouthpiece, mask and mask adapter should be disinfected

- **before using the unit for the first time,**
- **after the unit has not been used for a long period of time, or**
- **daily during normal use.**

Before disinfection, always first clean the parts as described in the section “How to clean the unit after each inhalation” on the previous page.

Disinfection of the individual parts can be done, using one of the following methods:

1. Disinfection by boiling.

Note: Main unit, medication container and flexible mask can NOT be boiled. For these parts, use other methods, as described below.

Mesh-cap, mouthpiece and mask-adapter can be disinfected by boiling in distilled water. After 10 to 30 minutes of boiling, shake off excessive water from the parts and let them air dry on a clean, lint free (paper) towel.

2. Disinfection by using alcohol.

All parts can be disinfected by using alcohol.

Note: Alcohol is highly flammable; do not use alcohol in close vicinity of open fire; do not smoke.

Soak the parts (NOT the main unit) in 70% ethyl alcohol for approx. 1 minute. Shake off excessive alcohol from the parts and let them air dry on a clean, lint free (paper) towel.

Alternatively, disinfect all parts by wiping them off with a lint-free cloth, soaked in alcohol.

3. Disinfection by commercially available disinfectant.







Note: Do NOT soak the main unit in any disinfectant.

Do not use disinfectant containing Sodium (Natrium) Hypochlorite; this may affect the metal parts.

For disinfection of the parts, refer to the instructions as supplied by the manufacturer of the disinfectant. After disinfection, thoroughly rinse the parts with warm tap water. Shake off excessive water from the parts and let them air dry on a clean, lint free (paper) towel.

How to disinfect the unit each day

Use the table below as a guideline to select a method for disinfecting.

Parts	Materials	Boiling	Alcohol	Sodium hypochlorite	Quaternary ammonium	Chlorhexidine	Amphoteric surfactant
			Disinfecting ethanol	Milton (0.1%)	Osvan (0.1%)	Hibitane (0.5%)	Tego (0.2%)
Mouthpiece 	SEBS	○	○	○	○	○	○
Mask Adapter 	PC	○	○	○	○	○	○
Medication Container 	Body : PSF Horn : Titanium Hinges : Titanium Packing : Silicone	×	○	×	○	○	○
Mesh Cap 	Cap: PSF Packing : Silicone Mesh Holder : PC Mesh : NiPd	○	○	×	○	○	○
Adult Mask (PVC) 	Mask : PVC Band : Rubber (non-latex)	×	○	○	○	○	○
Child Mask (PVC) 	Mask : PVC Band : Rubber (non-latex)	×	○	○	○	○	○

○ : applicable × : not applicable

How to replace the mesh cap

The mesh cap is a consumable part.

Omron recommends to exchange the mesh cap after approximately 1 year.

Remove the mesh cap and install a new one as described on page 10 (section “How to assemble the unit and fill the medication container”).

Additional instructions for Mesh care

In case the performance of the unit remains reduced even after cleaning and disinfecting, use the following methods to remove dried medication, lime or saliva which may clog the tiny holes in the mesh cap.

Leave the mesh cap in a white vinegar solution (1 part vinegar diluted with 3 parts of water) for ½ - 1 hour. In addition, the mesh cap may be kept overnight in a cup of distilled water, in which a tablet of dental (“false teeth”) cleaner has been added. After cleaning with vinegar or dental cleaner, be sure to shake off excessive solution, thoroughly but carefully rinse the mesh with distilled water. Shake off excessive water from the mesh cap and let it air-dry on a clean, lint free (paper) towel.

In case the unit nebulizes poorly even after following this procedure, replace the mesh cap.

Troubleshooting

Trouble	Possible cause	Corrective action
The nebulization rate is extremely low.	Batteries are low (the orange battery low indicator flashes).	Replace the batteries with new ones. Refer to page 9.
	The mesh is stained or clogged.	1. Clean the mesh by boiling. Refer to page 15. 2. Replace the mesh cap with a new one. Refer to page 10.
The green power indicator does not turn on and the unit does not nebulize.	The batteries are low.	Replace the batteries with new ones. Refer to page 9.
	The capacity of rechargeable batteries is low.	Charge the batteries with a commercially available recharger.
	The batteries are inserted in the wrong direction.	Re-insert the batteries in the correct direction. Refer to page 9.
	The medication container is not installed correctly to the main unit.	Remove the medication container from the main unit and install correctly. Refer to page 11.
The green power indicator turns on but the unit does not nebulize.	The vibrator is not immersed in the medication.	Tilt the main unit in order to immerse the vibrator in the medication.
	The medication container is not filled with medication.	Fill with medication. Refer to page 11.
	The mesh is broken.	Replace with a new one. Refer to page 10.

Troubleshooting

Trouble	Possible cause	Corrective action
The green power indicator turns on but the unit does not nebulize.	Medication or water has collected on the electrodes on the main unit.	Remove the medication or water. Refer to page 15.
	Excessive medication is collected on the mesh	Remove excessive medication. Refer to page 17.

If the unit does not nebulize properly after checking the possible causes above, contact your OMRON dealer.

Technical data

Name:	MicroAIR
Model:	U22 (NE-U22-E)
Type:	Electronic Mesh Nebulizer
Electrical:	3 VDC (two alkaline penlite batteries/Type AA/LR6) 2.4 VDC (two NiMH rechargeable batteries)
Power Consumption:	Approx. 1.5 W
Ultrasonic Frequency:	Approx. 180 KHz
Residual Volume:	Approx. 0.1 ml
Battery Life:	Approx. 8 days (30 minutes each day)
Operating Temperature/ Humidity:	10°C ~ 40°C, 30% ~ 85% RH
Storage Temperature/ Humidity/Air Pressure:	-20°C ~ 60°C, 10% ~ 95% RH, 700 ~ 1060 hPa
Weight:	Approx. 97 g (excl. batteries)
Dimensions:	Approx. 38 (W) x 104 (H) x 51 (D) mm
Contents:	Main Unit, Main Unit Cover, Medication Container, Mesh Cap, Mask Adapter, Mouthpiece, 2 Batteries (AA/LR6), Child Mask (PVC), Adult Mask (PVC), Soft Pouch, Instruction Manual, Warranty Card

Notes:

- Subject to technical modification without prior notice.
- This OMRON product is produced under the strict quality system of OMRON HEALTHCARE Co., Ltd., Japan.
- The device may not work if the temperature and voltage conditions are different to those defined in the specifications.
- Do not use the device where it may be exposed to flammable gas.
- This device complies with the provisions of the EC directive 93/42/EEC (Medical Device Directive) and the European Standard EN13544-1:2007, Respiratory therapy equipment - Part1: Nebulizing systems and their components.

 = Class II equipment

 = No operation

 = Type B

 = Power on

 Read the instruction manual carefully

CE 0197

Technical data

The particle size is measured according to the provisions of the EN13544-1:2007 "Respiratory therapy equipment - Part 1: Nebulizing systems and their components", Annex CC.3 using the multistage cascade impactor method.

Particle Size:	*MMAD 4.2 μm MMAD = Mass Median Aerodynamic Diameter
Medication Container Capacity:	7 ml maximum
Sound:	Less than 20 dB
Nebulization rate:	**Greater than 0.25 ml/min (by weight loss)
Aerosol Output:	*0.69 ml (2ml, 1%NaF)
Aerosol Output Rate:	*0.087 ml/min (2ml, 1%NaF)

Notes:

- The distribution of particle size and aerosol output are measured with 2.5% NaF solution. The particle size distribution and aerosol output may vary by combination of product, medication and ambient conditions such as temperature, humidity and atmospheric pressure.
 - Performance may vary with drugs such as suspensions or high viscosity. See drug supplier's data sheet for further details.
 - See web site of OMRON HEALTHCARE EUROPE to update technical information.
URL: www.omron-healthcare.com
- * Independently measured at SolAero Ltd., Canada, Dr. John Dennis, according to EN13544-1:2007.
** The Nebulization rate is measured with saline 0.9% solution at 23°C and can vary with medication and ambient conditions.

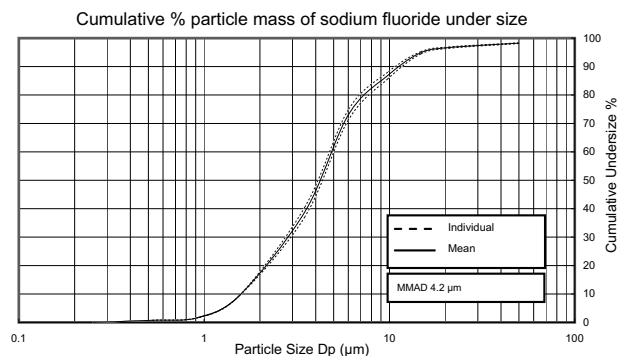

Technical data

Important information regarding Electro Magnetic Compatibility (EMC)

With the increased number of electronic devices such as PC's and mobile (cellular) telephones, medical devices in use may be susceptible to electromagnetic interference from other devices. Electromagnetic interference may result in incorrect operation of the medical device and create a potentially unsafe situation.

Medical devices should also not interfere with other devices.

In order to regulate the requirements for EMC (Electro Magnetic Compatibility) with the aim to prevent unsafe product situations, the EN60601-1-2 standard has been implemented. This standard defines the levels of immunity to electromagnetic interferences as well as maximum levels of electromagnetic emissions for medical devices.

This medical device manufactured by OMRON HEALTHCARE conforms to this EN60601-1-2:2007 standard for both immunity and emissions.

Nevertheless, special precautions need to be observed:

- Do not use mobile (cellular) telephones and other devices, which generate strong electrical or electromagnetic fields, near the medical device. This may result in incorrect operation of the unit and create a potentially unsafe situation. Recommendation is to keep a minimum distance of 7 m. Verify correct operation of the device in case the distance is shorter.

Further documentation in accordance with EN60601-1-2:2007 is available at OMRON HEALTHCARE EUROPE at the address mentioned in this instruction manual.

Documentation is also available at www.omron-healthcare.com.

Technical data



Correct Disposal of This Product (Waste Electrical & Electronic Equipment)

This marking shown on the product or its literature, indicates that it should not be disposed of, with other household wastes at the end of its working life. To prevent possible harm to the environment or human health from uncontrolled waste disposal, please separate this from other types of wastes and recycle it responsibly to promote the sustainable reuse of material resources.



Household users should contact either the retailer where they purchased this product, or their local government office, for details of where and how they can take this item for environmentally safe recycling.

Business users should contact their supplier and check the terms and conditions of the purchase contract. This product should not be mixed with other commercial wastes for disposal.

Optional Medical Accessories

(within the scope of EC Medical Device Directive 93/42/EEC)

Name	Model
Adult Mask (PVC)	NEB-MSLP-E
Child Mask (PVC)	NEB-MSMP-E
Mesh Cap	9518216-4
Medication Container	1140678-0
Mask Adapter	4997115-4
Mouthpiece	9520281-5

<p>Manufacturer</p> 	<p>OMRON HEALTHCARE Co., Ltd. 53, Kunotsubo, Terado-cho, Muko, KYOTO, 617-0002 JAPAN</p>
<p>EU-representative</p> 	<p>OMRON HEALTHCARE EUROPE B.V. Scorpius 33, 2132 LR Hoofddorp, THE NETHERLANDS www.omron-healthcare.com</p>
<p>Production facility</p>	<p>OMRON HEALTHCARE Co., Ltd. Matsusaka Factory 1855-370, Kubo-cho, Matsusaka-shi, Mie, 515-8503 Japan</p>
<p>Subsidiaries</p>	<p>OMRON HEALTHCARE UK LTD. Opal Drive, Fox Milne, Milton Keynes, MK15 0DG, UK www.omron-healthcare.co.uk</p>
	<p>OMRON MEDIZINTECHNIK HANDELSGESELLSCHAFT mbH Gottlieb-Daimler-Strasse 10, 68165 Mannheim, GERMANY www.omron-healthcare.de</p>
	<p>OMRON SANTÉ FRANCE SAS 14, rue de Lisbonne, 93561 Rosny-sous-Bois Cedex, FRANCE www.omron-healthcare.fr</p>

Made in Japan